

**ST1**

**MULTISYSTEM**

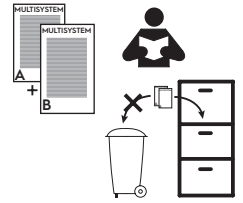

**1 - 9500.../...ST1**

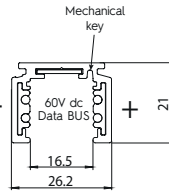
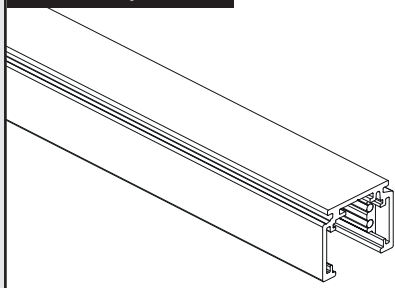
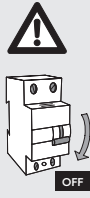

**2 - USE**

Ceiling - Wall



Suspended



**3 - CUTTING**

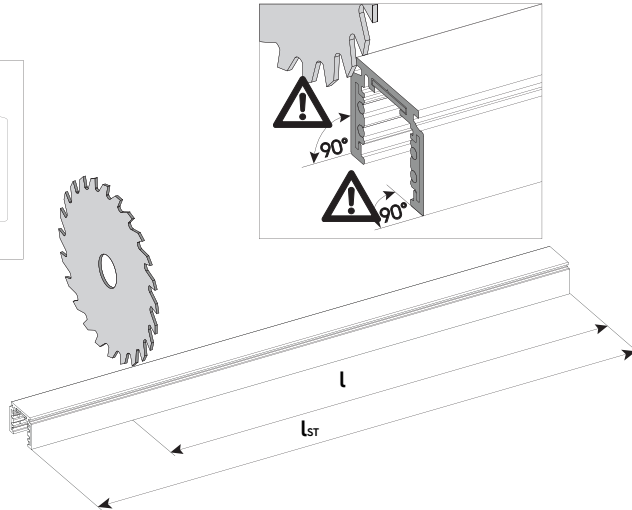
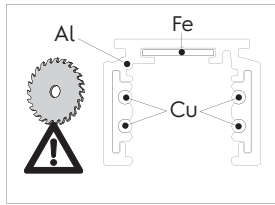

S-9000/T

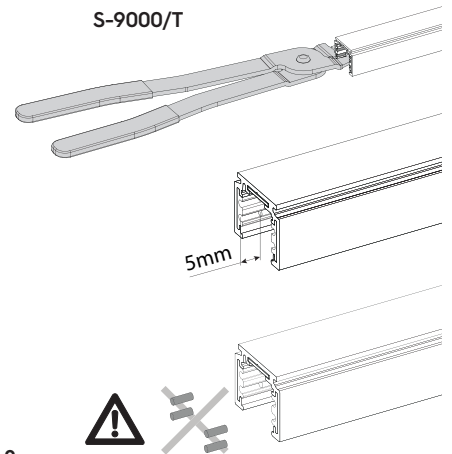

**4 - CEILING FIXING**

4a Standard

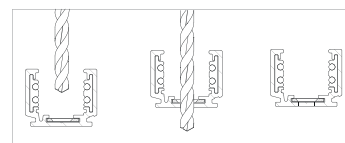
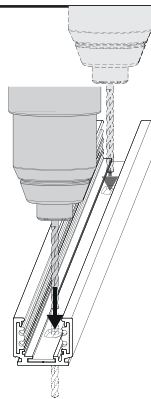

L (mm)

1000	250	500	250				
2000	250	500	500	500	250		
3000	250	500	500	500	500	500	250

1

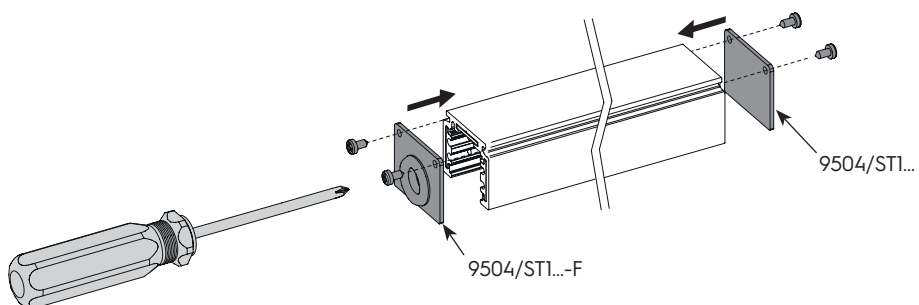

2

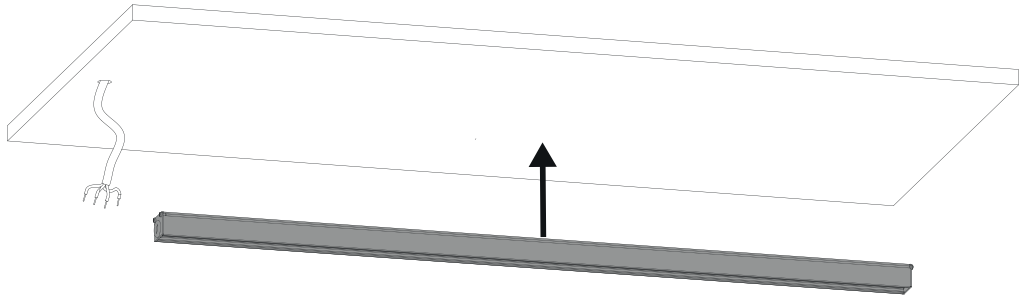

3

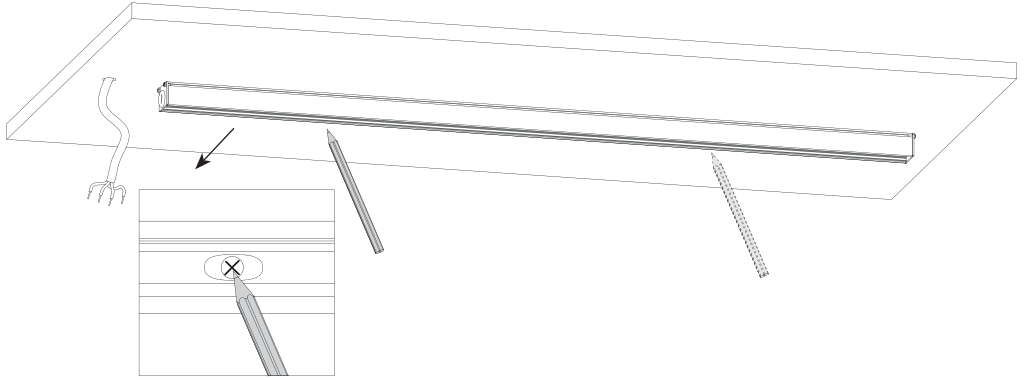

4

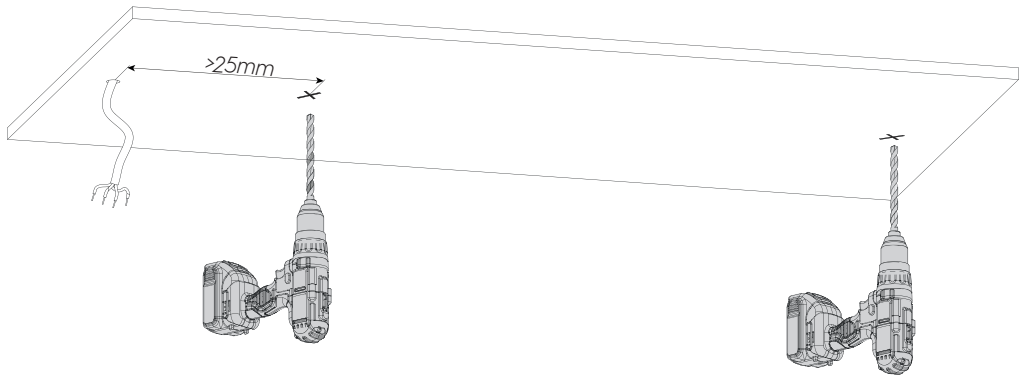

5

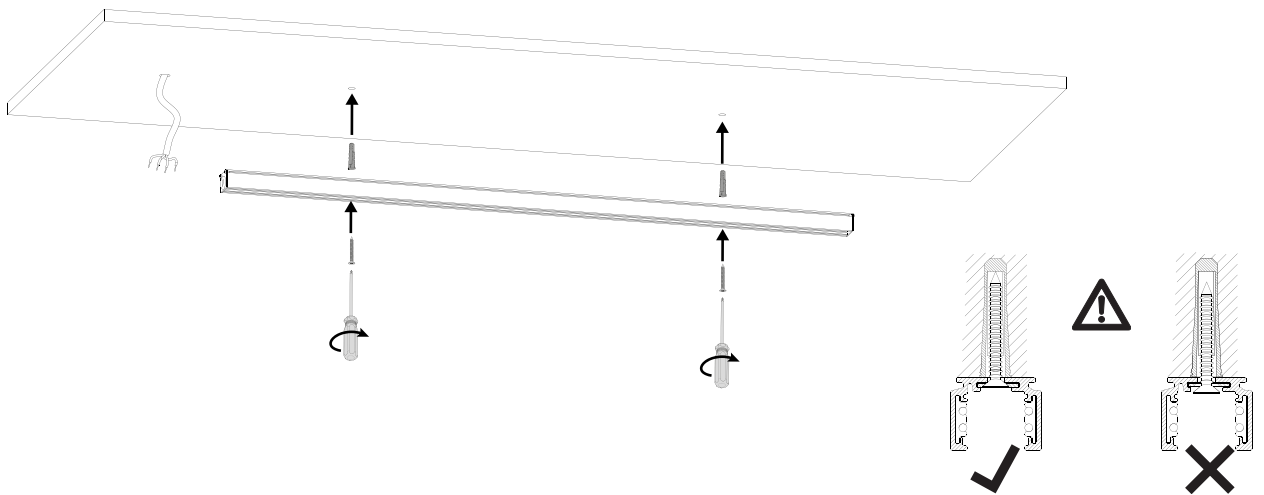

6

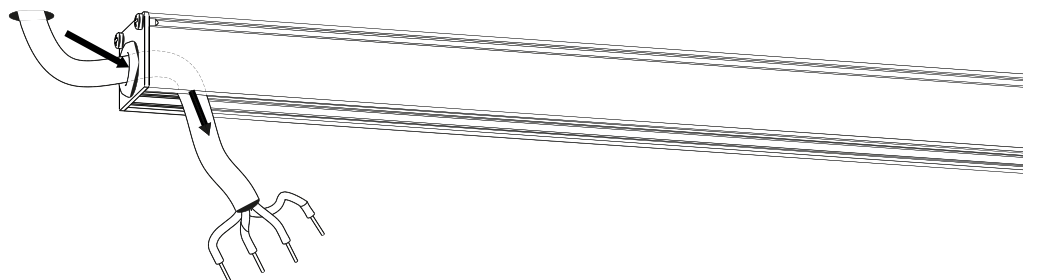

7

4b Cutted

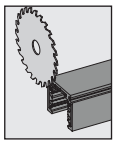

Ref. 3  
Cutting

1

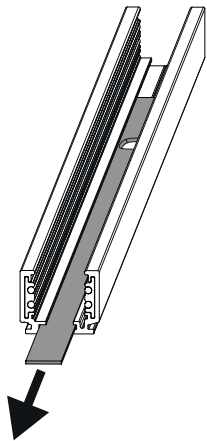

2

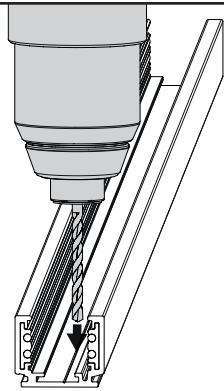

3

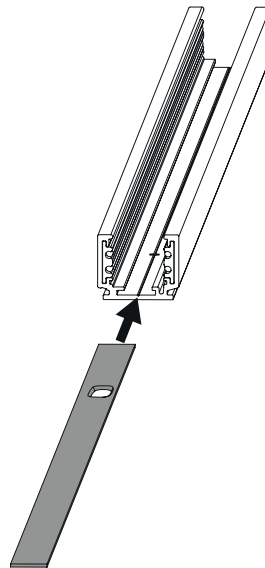

4

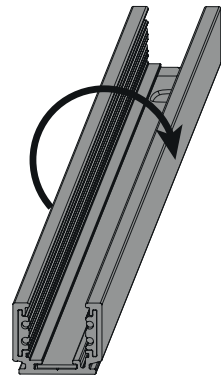

5

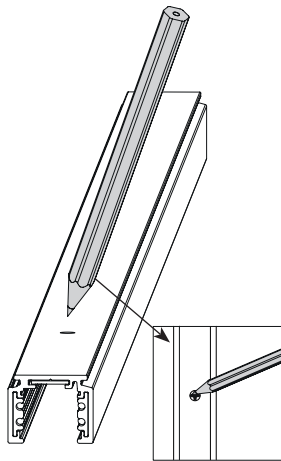

6

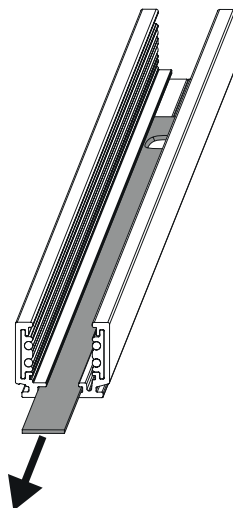

7

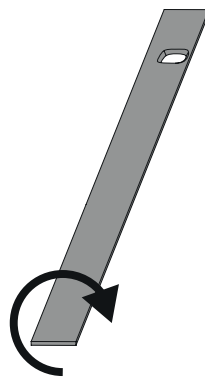

8

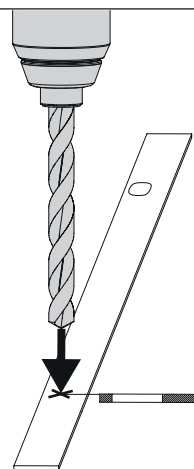

9

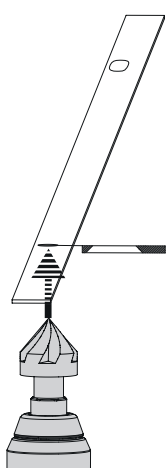

10

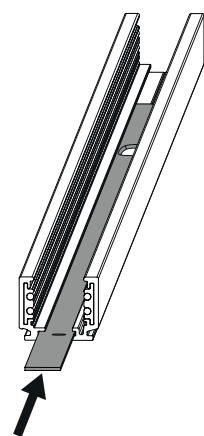

11

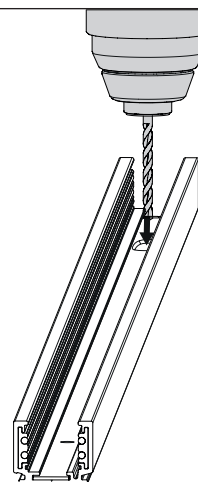

4a Standard  
fig. 2

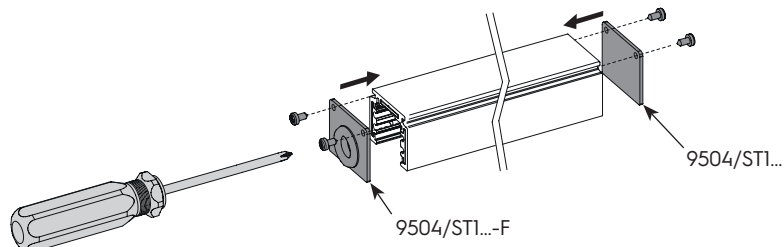

## 5 - SUSPENDED FIXING

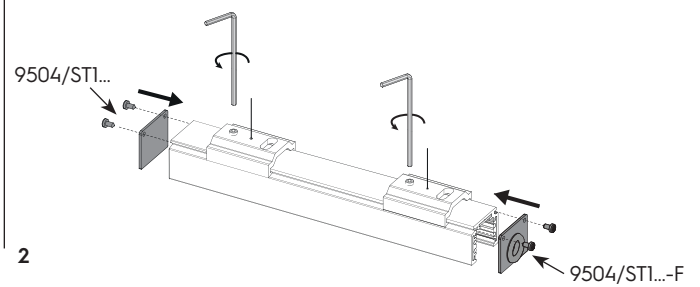
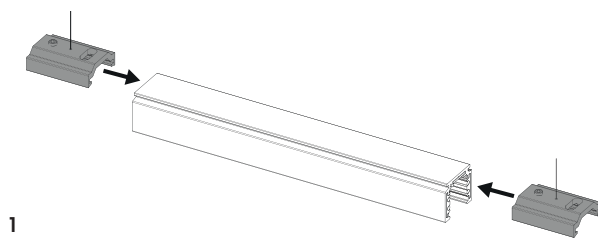
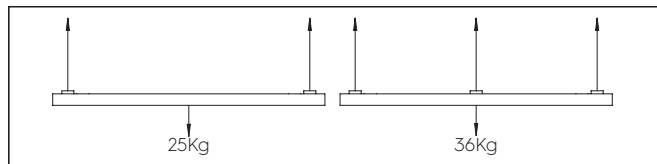
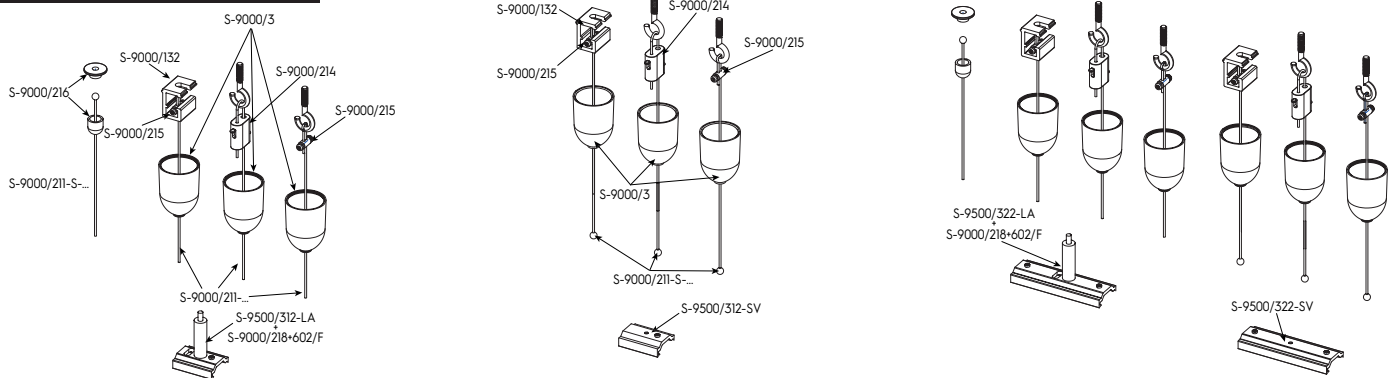

## 6 - IN ROW USE

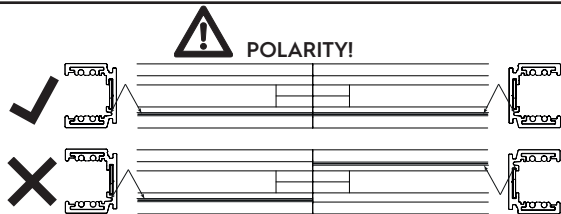
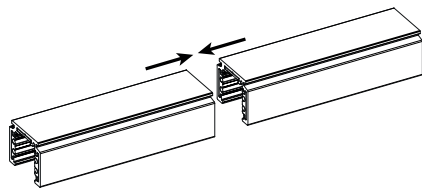

### 6a Ceiling

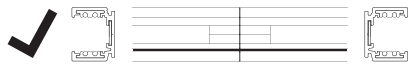
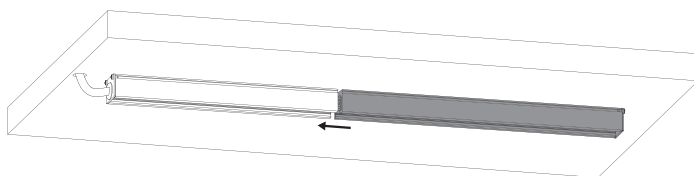

1

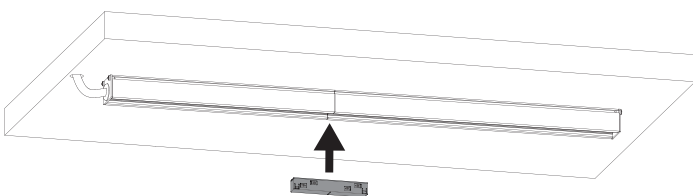

2

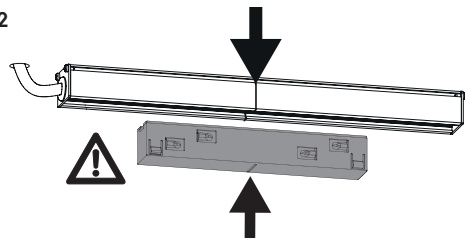

### 6b Suspended

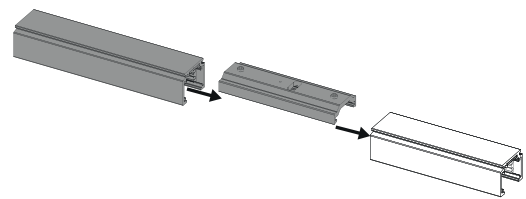
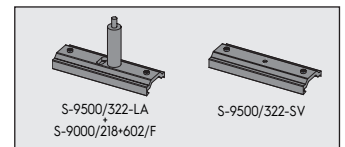

1

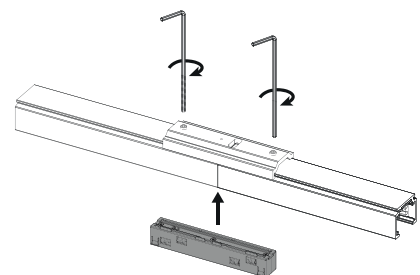

2

