

**S-9000/132**







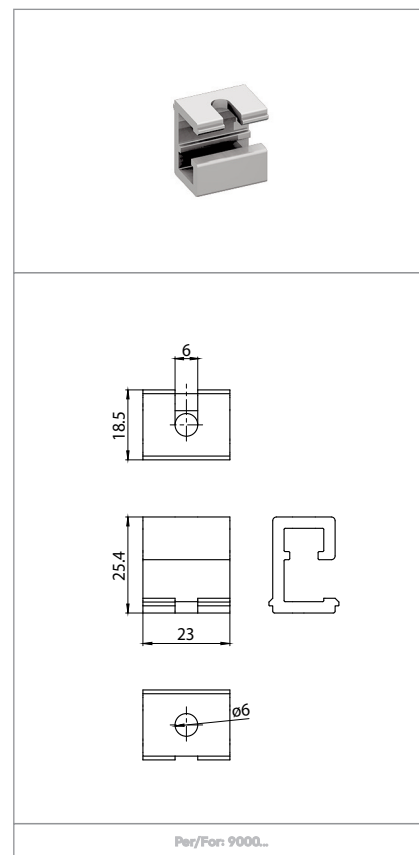

**STAFFA PER FISSAGGIO A SOFFITTO PER SOSPENSIONI**  
**CEILING BRACKET FOR SUSPENSIONS**

**Dati tecnici**  
*Technical data*











**Caratteristiche**  
*Characteristics*

In alluminio  
*In aluminium*

 fissaggio con vite <i>screw fixing</i>			
			
			

**Marchi di qualità**  
*Quality marks*

**Direttive Europee**  
*European directives*  
Conforme "RoHS"  
*"RoHS" compliant*

**Pesi e confezioni**  
*Weights and packaging*

Art. Codice prodotti <i>Product references</i>	g Peso netto <i>Net weight</i>	n° pz per sacco per bag	n° pz per scatola per box	n° pz per cartone per carton
S-9000/132				

**Note**

*Notes*

## ATTENZIONE

Tutte le operazioni di installazione e sostituzione dei componenti devono essere eseguite da personale specializzato, escludendo tensione dall'impianto e rispettando le norme nazionali d'installazione.

E' responsabilità dell'utente e/o dell'installatore assicurare la compatibilità elettrica, meccanica e termica del sistema rispetto alle strutture sulle quali viene ancorato e rispetto agli apparecchi ad esso connessi. Durante il montaggio dei binari rispettare le distanze di ancoraggio e non superare i carichi indicati nella relativa sezione.

Il binario ed i suoi componenti, compresi gli adattatori, non sono intercambiabili con accessori che non riportino il Marchio di Qualità.

Sul binario A.A.G. Stucchi è possibile utilizzare solo le connessione A.A.G. Stucchi. Le connessioni A.A.G. Stucchi possono essere utilizzate solo su binari A.A.G. Stucchi.

Il profilo del binario ha una chiave meccanica per rispettare il giusto collegamento tra gli spezzoni di binario.

## WARNING

All the installation and replacement operations must be done by specialized personnel only. Exclude voltage plant. Please respect national installation regulations.

The final user and/or the installer will take the responsibility of ensuring electric, mechanical and thermal compatibility of the system against the structures on which it will be mounted and against the devices connected to it. Do not exceed listed loading indicated in the relevant section and respect fixing distances during the track mounting.

The track, its components and also the adapters can't be used with accessories without the Quality Mark.

On A.A.G. Stucchi track one can use only A.A.G. Stucchi connections. A.A.G. Stucchi connections can be used only with A.A.G. Stucchi tracks

There is a mechanical key on the outline of the track to guarantee the right connection of the multiple pieces of the track.

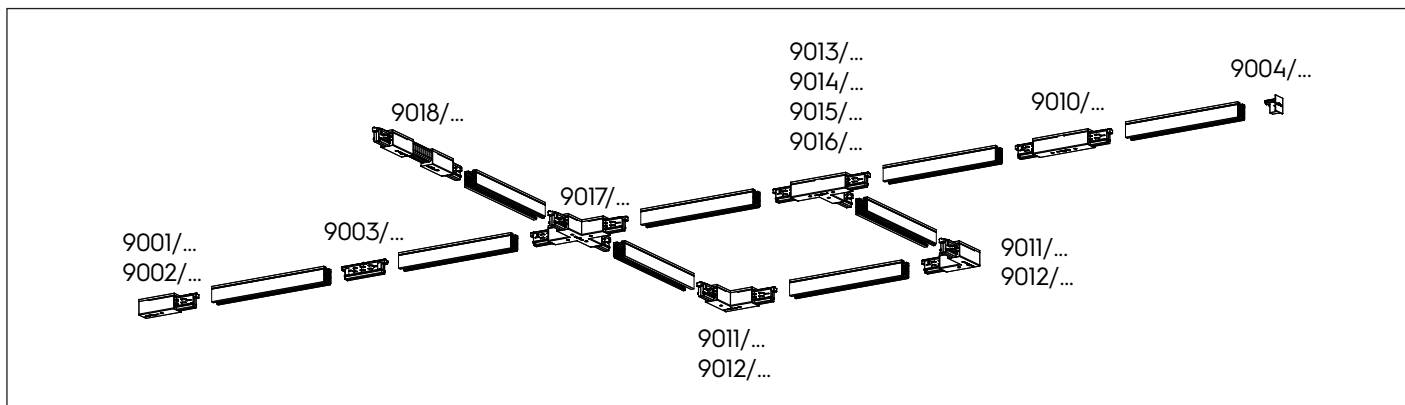

Anche le testate ed i giunti di collegamento presentano una chiave meccanica (presenza vite - vedi figura sotto) che deve essere tenuta in considerazione per la scelta del giusto componente.

Nei disegni di catalogo di questi accessori il posizionamento della chiave meccanica è evidenziato da una linea rossa.

Also end-feeds and connection joints have a mechanical key (screw presence as per picture below) that must be taken into account in order to choose the right component.

In the catalogue sketches of this articles the position of the key is highlighted with a red line.

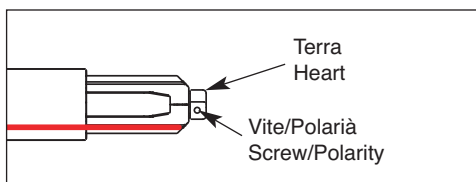

## Avvertenze per la sicurezza e l'installazione

A.A.G. Stucchi permette solo l'utilizzo dei componenti A.A.G. Stucchi all'interno delle applicazioni che utilizzano il sistema ONETRACK. Questi componenti devono essere installati secondo le istruzioni di montaggio fornite dall'azienda.

L'azienda, come produttrice, non è responsabile della sicurezza e del funzionamento del sistema in caso si utilizzino componenti non appartenenti ad esso o se le istruzioni di montaggio non venissero rispettate. E' inoltre responsabilità dell'utente garantire la compatibilità elettrica, meccanica e termica tra il sistema ONETRACK e gli apparecchi di illuminazione utilizzati.

## Safety warnings for products and installation

A.A.G. Stucchi allows to use only A.A.G. Stucchi parts in applications where ONETRACK system is used. These parts must be installed according to the installation instructions.

The company as a manufacturer is not responsible for the safety and functioning of the system if parts not belonging to it are used or if any deviation from the installation instructions occurs. It is then the user's responsibility to ensure the electrical, mechanical and thermal compatibility between the product and the fixtures used with it.

**Schemi di montaggio**  
*Assembly diagrams*

**KIT PER FISSAGGIO  
CON SOSPENSIONI**  
**SUSPENSION KITS**

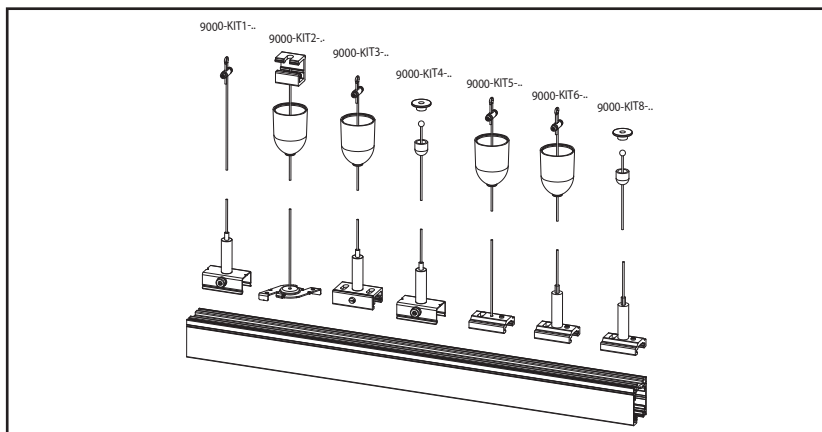

**SOSPENSIONI CON REGOLAZIONE SUL BINARIO**  
**SUSPENSIONS WITH TRACK REGULATION**

**SET PER FISSAGGIO CON  
SOSPENSIONI RIGIDE**  
**RIGID SUSPENSION SETS**

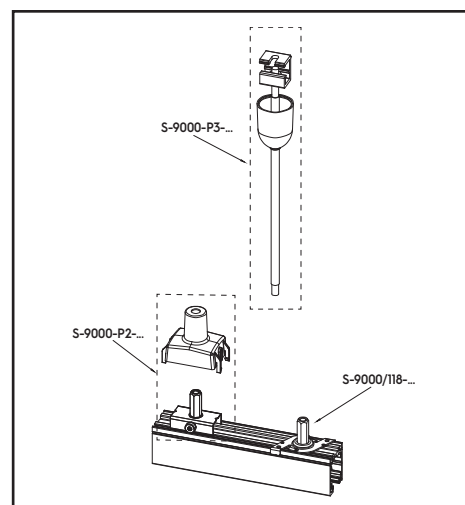
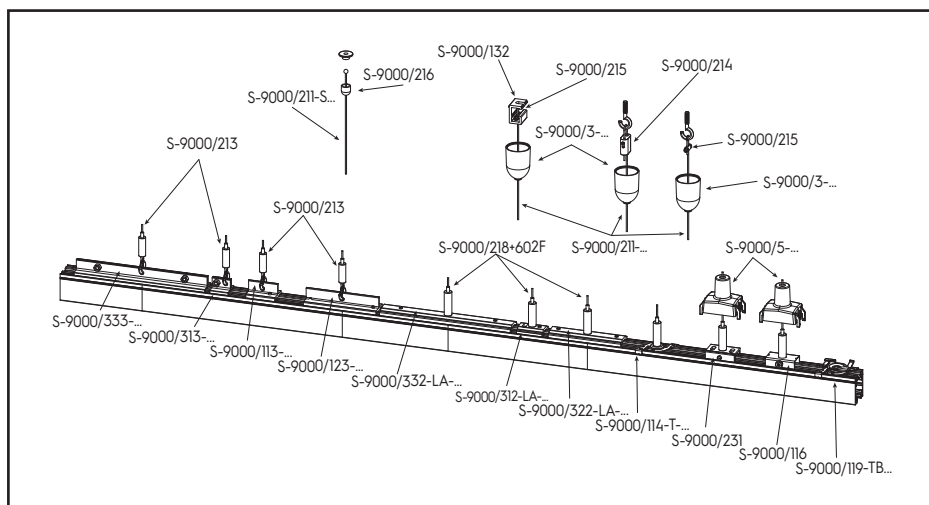

**SOSPENSIONE CON REGOLAZIONE A PLAFONE**  
**SUSPENSIONS WITH CEILING REGULATION**

**SET PER FISSAGGIO A  
SOSPENSIONE**  
**SUSPENSION SETS**

**FISSAGGIO A  
PLAFONE**  
**CEILING FIXING**

