

**3254-12/S-TR**

**3254-12/S-SN-TR**

**3254-12/C-TR**

**3254-12/C-SN-TR**

**PORTALAMPADE A COLONNA PER LAMPADE FLUORESCENTI LINEARI T8-T12**

*TOMBSTONE LAMPHOLDERS FOR T8-T12 FLUORESCENT LINEAR LAMPS*

**Dati tecnici**

*Technical data*

- Attacco lampada - Lamp cap	<b>G13</b>
- Corrente e tensione nominale - Rated current and voltage	<b>2A-500V 2A-250V (.../C-...)</b>
- Temperatura massima di funzionamento (IEC) - Maximum operating temperature (IEC)	<b>T140 Tm110</b>
- Grado di protezione - Protection index	<b>IP20</b>
- Categoria di sovratensione - Impulse withstand category	<b>II</b>

**Caratteristiche**

*Characteristics*

- Corpo in policarbonato trasparente  
- *Transparent polycarbonate body*
- Contatti in lega di rame  
- *Copper alloy contacts*
- Con top test  
- *With top test*

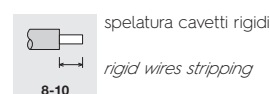
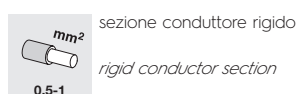
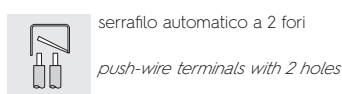
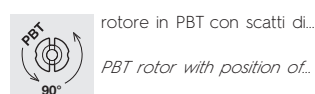
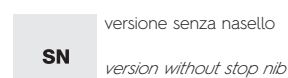
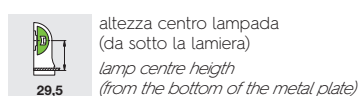
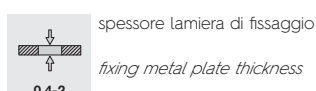
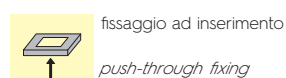
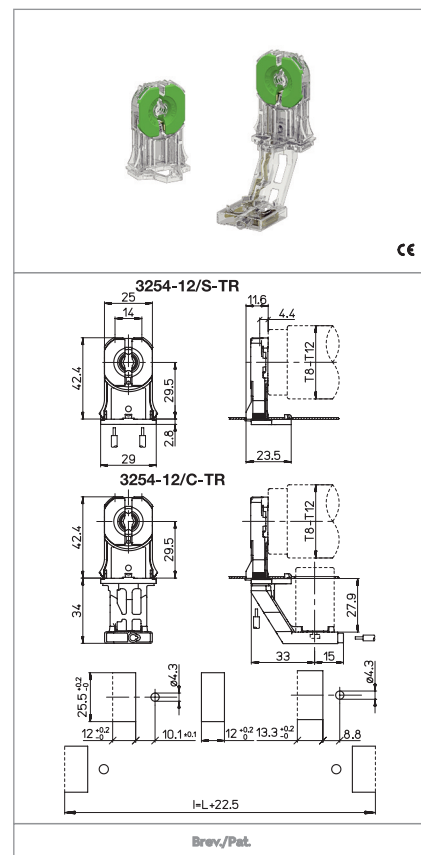

**Marchi di qualità**

*Quality marks*

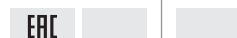

**Direttive Europee**

*European directives*

Conforme "RoHS"  
*"RoHS" compliant*  
Non soggetto alla "RAEE"  
*Not subject to "WEEE"*

**Pesi e confezioni**

*Weights and packaging*

Art. Codice prodotti <i>Product references</i>	g Peso netto <i>Net weight</i>	n° pz per sacco per bag	n° pz per scatola per box	n° pz per cartone per carton
<b>3254-12/S-TR</b>	<b>6,2</b>	<b>500</b>		
<b>3254-12/S-SN-TR</b>	<b>6,2</b>	<b>500</b>		
<b>3254-12/C-TR</b>	<b>11,2</b>	<b>250</b>		
<b>3254-12/C-SN-TR</b>	<b>11,2</b>	<b>250</b>		

**Note**

*Notes*