

3254-10/S-TR

3254-10/S-SN-TR

PORTALAMPADE A COLONNA PER LAMPADE FLUORESCENTI LINEARI T8-T12
TOMBSTONE LAMPHOLDERS FOR T8-T12 FLUORESCENT LINEAR LAMPS

Dati tecnici

Technical data







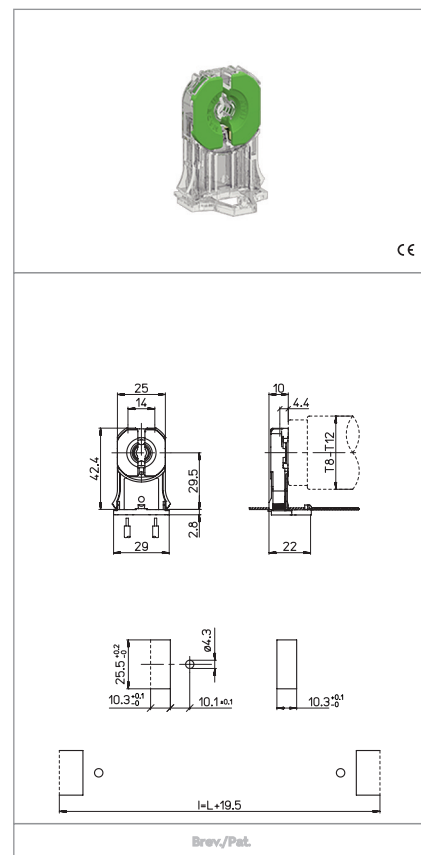

- Attacco lampada - Lamp cap	G13
- Corrente e tensione nominale - Rated current and voltage	2A-500V
- Temperatura massima di funzionamento (IEC) - Maximum operating temperature (IEC)	T140 Tm110
- Grado di protezione - Protection index	IP20
- Categoria di sovratensione - Impulse withstand category	II

Caratteristiche

Characteristics

- Corpo in policarbonato trasparente
- Transparent polycarbonate body
- Contatti in lega di rame
- Copper alloy contacts
- Con top test
- With top test



 fissaggio ad inserimento push-through fixing	 spessore lamiera di fissaggio fixing metal plate thickness 0,4-2	 altezza centro lampada (da sotto la lamiera) lamp centre height (from the bottom of the metal plate) 29,5	 versione senza nasello version without stop nib SN
 rotore in PBT con scatti di 90° PBT rotor with position of... 90°	 serrafilo automatico a 2 fori push-wire terminals with 2 holes	 sezione conduttore rigido rigid conductor section 0,5-1	 spelatura cavetti rigidi rigid wires stripping 8-10

Marchi di qualità

Quality marks

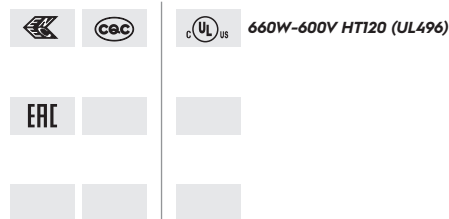

Direttive Europee

European directives

Conforme "RoHS"
"RoHS" compliant
Non soggetto alla "RAEE"
Not subject to "WEEE"

Pesi e confezioni

Weights and packaging

Art. Codice prodotti Product references	g Peso netto Net weight	n° pz per sacco per bag	n° pz per scatola per box	n° pz per cartone per carton
3254-10/S-TR	6,2	500		
3254-10/S-SN-TR	6,2	500		

Note

Notes