

## 285/FAU-TR 285/MAU-TR

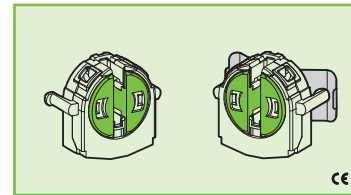

### PORTALAMPADE A PASTIGLIA PER LAMPADE FLUORESCENTI LINEARI T5 ROUND LAMPHOLDERS FOR T5 FLUORESCENT LINEAR LAMPS

#### Dati tecnici







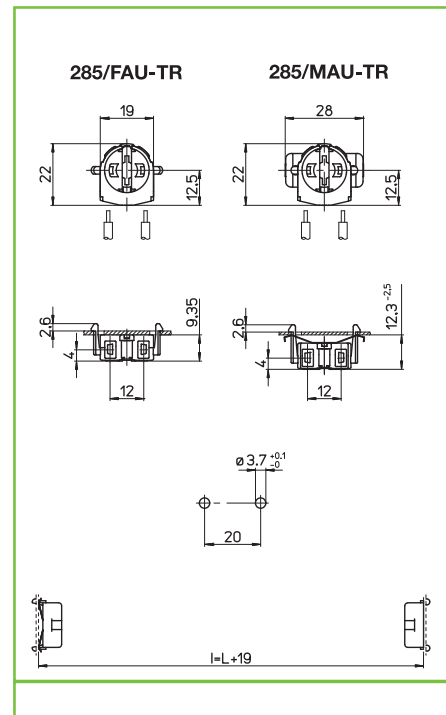

##### Technical data

- Attacco lampada - Lamp cap	<b>G5</b>
- Corrente e tensione nominale - Rated current and voltage	<b>2A-500V</b>
- Temperatura massima di funzionamento (IEC) - Maximum operating temperature (IEC)	<b>T130 Tm110</b>
- Grado di protezione - Protection index	<b>IP20</b>
- Categoria di sovratensione - Impulse withstand category	<b>III</b>

#### Caratteristiche Characteristics

- Corpo in policarbonato trasparente  
- Transparent polycarbonate body
- Contatti in lega di rame  
- Copper alloy contacts
- Con top test  
- With top test



 fissaggio ad innesto posteriore, fisso <i>back mounting, fixed</i>	 fissaggio ad innesto posteriore, mobile <i>back mounting, adjustable</i>	 spessore lamiera di fissaggio <i>fixing metal plate thickness</i> 0,6-1,2	 spessore <i>thickness</i> 9,35
 rotore in PBT verde con scatti di... <i>PBT green rotor with position of...</i>	 serrafilo automatico a 2 fori <i>push-wire terminals with 2 holes</i>	 sezione conduttore rigido <i>rigid conductor section</i> 0,5-1	 spelatura cavetti rigidi <i>rigid wires stripping</i> 8-9
 IP40 1115			

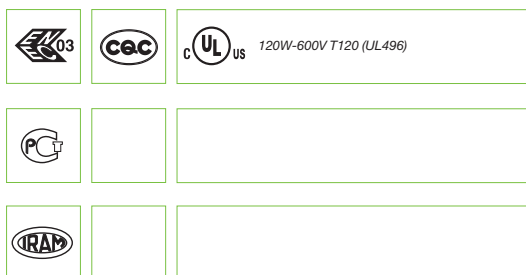

#### Marchi di qualità Quality marks



#### Direttive Europee European directives

Conforme "RoHS"  
"RoHS" compliant  
Non soggetto alla "RAEE"  
Not subject to "WEEE"

#### Pesi e confezioni Weights and packaging

Art. codice prodotti product references	g peso netto net weight	 pezzi per sacco pieces per bag	 pezzi per scatola pieces per box
285/FAU-TR	2,9		
285/MAU-TR	3,4		

#### Note Notes