

## 441/V

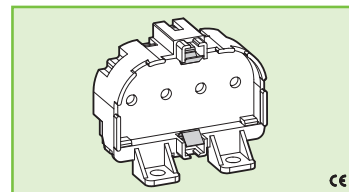

### PORTALAMPADE PER LAMPADE FLUORESCENTI COMPATTE (TC-L) LAMPHOLDER FOR COMPACT FLUORESCENT LAMPS (TC-L)

#### Dati tecnici

##### Technical data









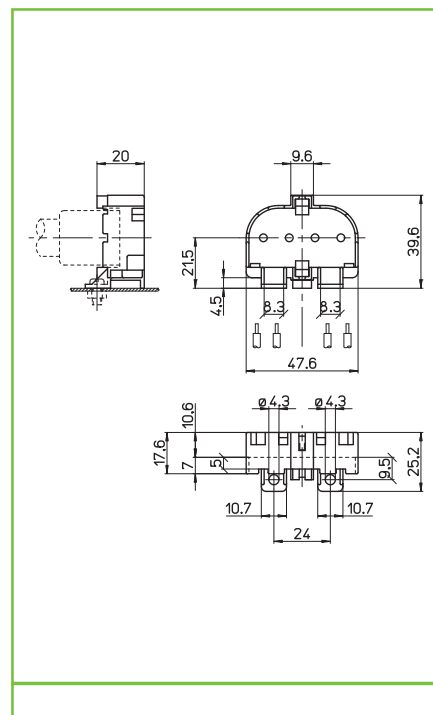



- Attacco lampada - Lamp cap	<b>2G11</b>
- Corrente e tensione nominale - Rated current and voltage	<b>2A-500V</b>
- Temperatura massima di funzionamento (IEC) - Maximum operating temperature (IEC)	<b>T140</b>
- Grado di protezione - Protection index	<b>IP20</b>
- Categoria di sovratensione - Impulse withstand category	<b>III</b>

#### Caratteristiche





##### Characteristics

- Corpo in PBT  
— PBT body
- Contatti in lega di rame  
— Copper alloy contacts



 fissaggio con vite screw fixing	 altezza centro lampada (da sopra la lamiera) lamp centre height (from the top of the metal plate)	 serrafilo automatico a 2 fori push-wire terminals with 2 holes	 sezione conduttore rigido rigid conductor section
 spelatura cavetti rigidi rigid wires stripping	 21,5	 1128	 120
			



#### Marchi di qualità Quality marks

		 (660W-600V)
		
		

#### Direttive Europee European directives

Conforme "RoHS"  
"RoHS" compliant  
Non soggetto alla "RAEE"  
Not subject to "WEEE"

#### Pesi e confezioni Weights and packaging

Art. codice prodotti product references	g peso netto net weight	 pezzi per sacco pieces per bag	 pezzi per scatola pieces per box
441/V	15,9	500	100

#### Note