

441/AU

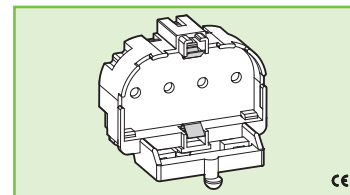

PORTALAMPADE PER LAMPADE FLUORESCENTI COMPATTE (TC-L) LAMPHOLDER FOR COMPACT FLUORESCENT LAMPS (TC-L)

Dati tecnici

Technical data







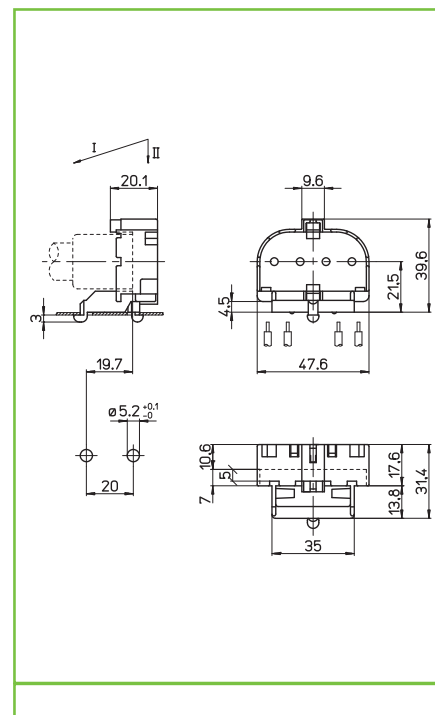

- Attacco lampada - Lamp cap	2G11
- Corrente e tensione nominale - Rated current and voltage	2A-500V
- Temperatura massima di funzionamento (IEC) - Maximum operating temperature (IEC)	T140
- Grado di protezione - Protection index	IP20
- Categoria di sovratensione - Impulse withstand category	III

Caratteristiche

Characteristics





- Corpo in PBT
— PBT body
- Contatti in lega di rame
— Copper alloy contacts



 fissaggio automatico ad innesto <i>push fixing</i>	 spessore lamiera <i>metal plate thickness</i> 0,6-1,2	 altezza centro lampada (da sopra la lamiera) <i>lamp centre height</i> (from the top of the metal plate) 21,5	 serrafilo automatico a 2 fori <i>push-wire terminals with 2 holes</i>
 sezione conduttore rigido <i>rigid conductor section</i> 0,5-1	 spelatura cavetti rigidi <i>rigid wires stripping</i> 8-9	 132 1132	 1128
 120			

Marchi di qualità

Quality marks



Direttive Europee

European directives

Conforme "RoHS"
"RoHS" compliant
Non soggetto alla "RAEE"
Not subject to "WEEE"

Pesi e confezioni

Weights and packaging

Art. codice prodotti <i>product references</i>	g peso netto <i>net weight</i>	 pezzi per sacco <i>pieces per bag</i>	 pezzi per scatola <i>pieces per box</i>
441/AU	17,2	500	100

Note

Notes