

401/V

PORTALAMPADE PER LAMPADE FLUORESCENTI COMPATTE (TC-S)

LAMPHOLDER FOR COMPACT FLUORESCENT LAMPS (TC-S)

Dati tecnici

Technical data





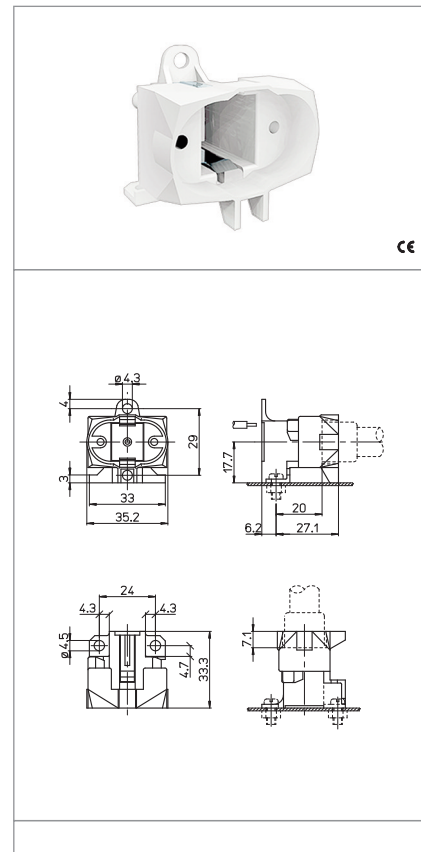

- Attacco lampada - Lamp cap	G23
- Corrente e tensione nominale - Rated current and voltage	2A-250V
- Temperatura massima di funzionamento (IEC) - Maximum operating temperature (IEC)	T140
- Grado di protezione - Protection index	IP20
- Categoria di sovratensione - Impulse withstand category	III

Caratteristiche

Characteristics

- Corpo in PBT bianco
- White PBT body
- Contatti in lega di rame
- Copper alloy contacts



 fissaggio con vite <i>screw fixing</i>	 altezza centro lampada (da sopra la lamiera) <i>lamp centre height</i> (from the top of the metal plate) 17,7	 serrafilo automatico ad 1 foro <i>push-wire terminals with 1 hole</i>	 sezione conduttore rigido <i>rigid conductor section</i> 0,5-1
 spelatura cavetti rigidi <i>rigid wires stripping</i> 8-9	 130		

Marchi di qualità

Quality marks

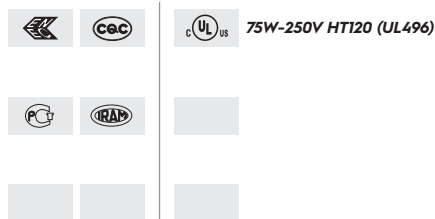

Direttive Europee

European directives

Conforme "RoHS"
"RoHS" compliant
Non soggetto alla "RAEE"
Not subject to "WEEE"

Pesi e confezioni

Weights and packaging

Art. Codice prodotti Product references	g Peso netto Net weight	n° pz per sacco per bag	n° pz per scatola per box	n° pz per cartone per carton
401/V	11,4	500	200	

Note

Notes